

# BIANCO **iCON** SERIES **CONTROLS**

## Installation and Operation Manual

### SPC1-22S



## Conventions used in this manual.

In the manual the following symbols will be used:



Generic danger. Failure to comply with the safety regulations that follow can irreparably damage the controller or equipment.



Electric shock risk. Failure to comply with the safety regulations that follow can cause death or serious injury.

### WARNINGS

Read this manual carefully before any operation.

Please keep this manual for future use.



#### WARNING!!

1. Installation must be carried out by a suitably qualified electrician.
2. Before carrying out any installation or maintenance operation, controller must be disconnected from the power supply.
3. Do not open the cover during running the controller.
4. Do not splash water or other liquid over the controller.
5. Do not allow children or infirm persons to operate the control.
6. Qualified electrician is to correctly size and install circuit breakers to protect power supply.



#### CAUTION!!

1. The electrical and hydraulic connections must be carried out by competent, skilled, qualified personnel.
2. Never connect AC power to the output terminals.
3. Ensure the pump and controller characteristics match.
4. Do not install the controller in the following conditions:
  - a. Vibration and mechanical shock.
  - b. Corrosive gasses and liquids.
  - c. Extreme heat and cold, operating range  $-25^{\circ}\text{C}$  -  $+55^{\circ}\text{C}$ .
  - d. Salt mist corrosion.
  - e. Rain and moisture.
  - f. Flammable materials, solvents.

## TABLE OF CONTENTS

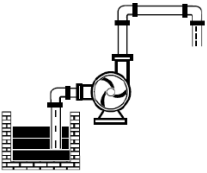
	Page
1.0 INTRODUCTION	
1.1 Applications	4
1.2 Technical parameters and features	4
1.3 Meanings of the icons shown on the LCD	6
	
2.0 INSTALLATION – DRAINAGE	
2.1 Electrical connection to the power supply and pump	7
2.2 Electrical connections for DRAINAGE applications	8
2.2.1 Installing level transducer and PVC pipeline	8
2.2.2 Installing level transducer	9
2.2.3 Electrical connections	10
3.0 OPERATION	
3.1 BEFORE YOU START – Parameter calibration and erasing	11
3.2 Switching to AUTO mode	12
3.3 Switching to MANUAL mode	13
3.4 Auto Patrol	13
3.5 Alarm Test and Mute	13
3.6 Pump protection	13
3.7 Last five failure record	13
3.8 Pump accumulated running time	14
4.0 SETTING LEVELS	
4.1 Cut off depth value setting	15
4.2 Cut in depth value setting	15
4.3 High level alarm setting	16
5.0 COMMUNICATION LINK	16
5.1 Basic Function	17
5.2 Special application	17
5.3 Technical parameters	17
6.0 TROUBLE SHOOTING GUIDE	18

## 1.0 Introduction

Thank you for choosing a Bianco Icon Series Intelligent Pump Controller.

The Intelligent Pump Controller model is an easy to use, programmable controlling and protection device for direct start, single phase pumps with output power from 0.37kW – 2.2kW.

Important features that distinguish the Bianco Icon Series Intelligent Pump Controllers from some other controllers are the push button calibration of overload and ability for dry run protection without float switches or probes.

### 1.1 Applications

The model SPC1-22S is specifically designed for sewage and storm water systems where sump or tank capacity or conduit size prevents the use of float switches. By adopting a level transducer with 0.5 – 4.5 V analogue signal (0 – 2.0 m), the installer can easily set the different liquid depths for pump operation and observe the dynamic liquid depth in the sump or tank.

### 1.2 Technical parameters and features

- Single pump control
- Level transducer (0 - 2.0m) with 0.5 – 4.5 V analogue signal
- Easy to set liquid depths for pump operation and to observe dynamic liquid levels
- Eliminates the need for float switches or level probes
- Auto/manual switch
- Protect the pump against many faults
- Push button calibration
- Dynamic LCD displaying the real liquid depth
- Dynamic LCD displaying pump running information
- Pump accumulative running time
- Last five fault record
- RS485 communication
- Dry run protection without float switches or probes
- Auto Patrol (anti-seize) function runs pumps for 3 seconds, every 10 days after last use

The following chart shows main technical parameters for the Controller SPC1-22S

**Main technical characteristic**

Control characteristic	Liquid level control
Control method	Manual/Auto
Liquid level control characteristic	Level transducer

**Main technical data**

Rated output power	0.37 - 2.2 kW (0.5 - 3.0 hp)
Rated input voltage	240V
Trip response time of overload	5 sec - 5 min
Trip response time of open phase	< 2 sec
Trip response time of short circuit	< 0.1 sec
Trip response time of under/over voltage	< 5 sec
Trip response time of dry run	6 sec
Recovery time of over load	30 min
Recovery time of under/over voltage	5 min
Recovery time of dry run	30 min
Trip voltage of over voltage	115% of rated input voltage
Trip voltage of under voltage	80% of rated input voltage
Liquid level transfer distance maximum	1000m
Protection functions	Dry run Over load Transient voltage Under voltage Over voltage Pump stalled Short circuit, repeated starts,









**Main installation data**

Working temperature	-25 to +55 deg C
Working humidity	20% to 90% Relative Humidity, non-condensing
Degree of protection	IP54
Install position	Vertical
Unit dimensions (L x W x H)	30.2 x 24.0 x 12.0 cm

**RS485 technical data**

Physical interface	RS485 Bus Interface: asynchronous semi duplex
Baud rate	1200,2400,4800,9600 bps (default 9600bps)
Protocol type	MODBUS protocol (RTU)

### 1.3 Meanings of the icons shown on the LCD.

Icon	Meaning / Description
	pump parameter configuration icon, when this icon appears, pump control box is parameter setting
	time displaying icon, when this icon appears, it means pump control box is displaying some parameter of time, eg: pump accumulated running time (unit: hour); counting down etc
	pump fault icon, when this icon appears, it means pump control box is displaying some fault information
	network connection error icon, when this icon appears, it means there is no network connections or network connection error between pump control box and SC(slave controller) or computer
	network normal connection icon, when this icon appears, it means the network connection between pump control box and SC (slave controller) or computer is normal
<b>V</b>	voltage
<b>M</b>	minute
<b>S</b>	second
<b>H</b>	hour
<b>%</b>	percent
<b>A</b>	ampere
	pump running
	pump stopped
	low pressure or lack of pressure in the pipeline or pressure tank
	high pressure or full of pressure in the pipeline or pressure tank
<b>A</b>	pump A
<b>B</b>	pump B (for dual pump controllers)

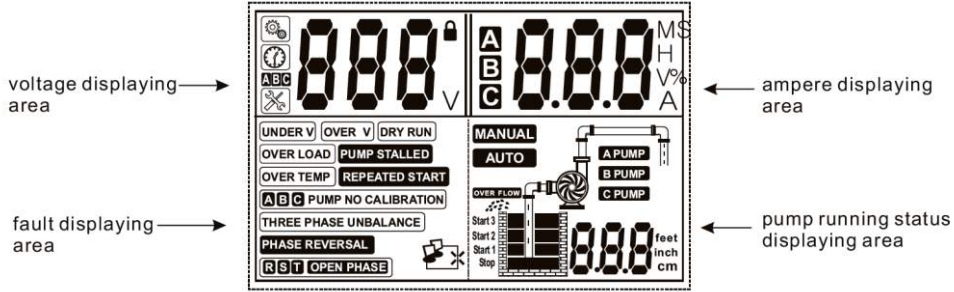

## 2.0 Installation – DRAINAGE

### 2.1 Electrical connection to the power supply and pump

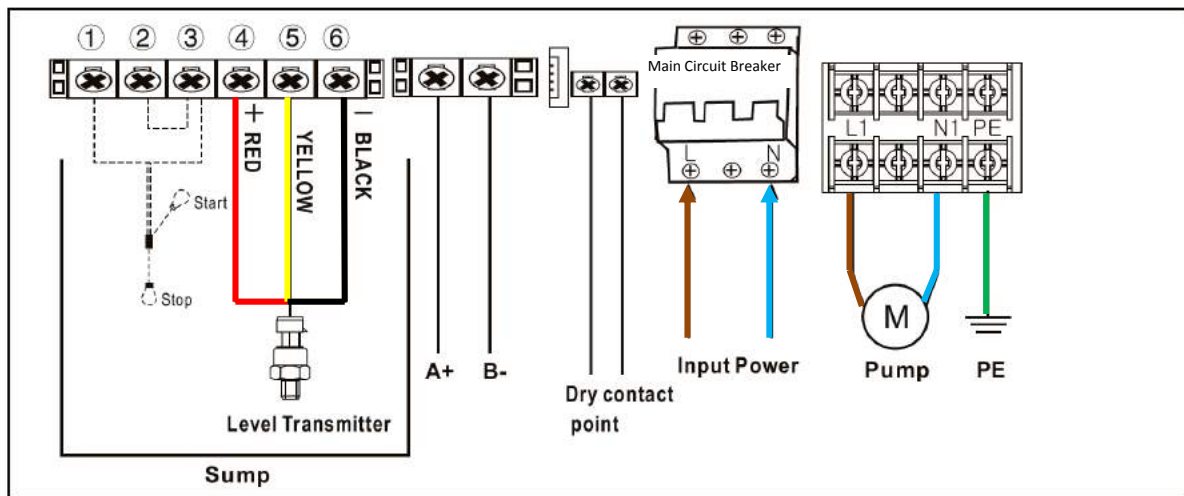

 **DANGER.** Electric shock risk.

Before carrying out any installation or maintenance operation, the control panel should be disconnected from the power supply and one should wait at least 2 minutes before opening the control panel.

 Never connect AC power to output L1 N1 terminals.

 Ensure the motor, controller and power specifications match.

 The electrical and hydraulic connections must be carried out by competent, skilled, qualified personnel.

## 2.2 Electrical connections for DRAINAGE applications

### 2.2.1 Installing Level Transducer and PVC pipeline.

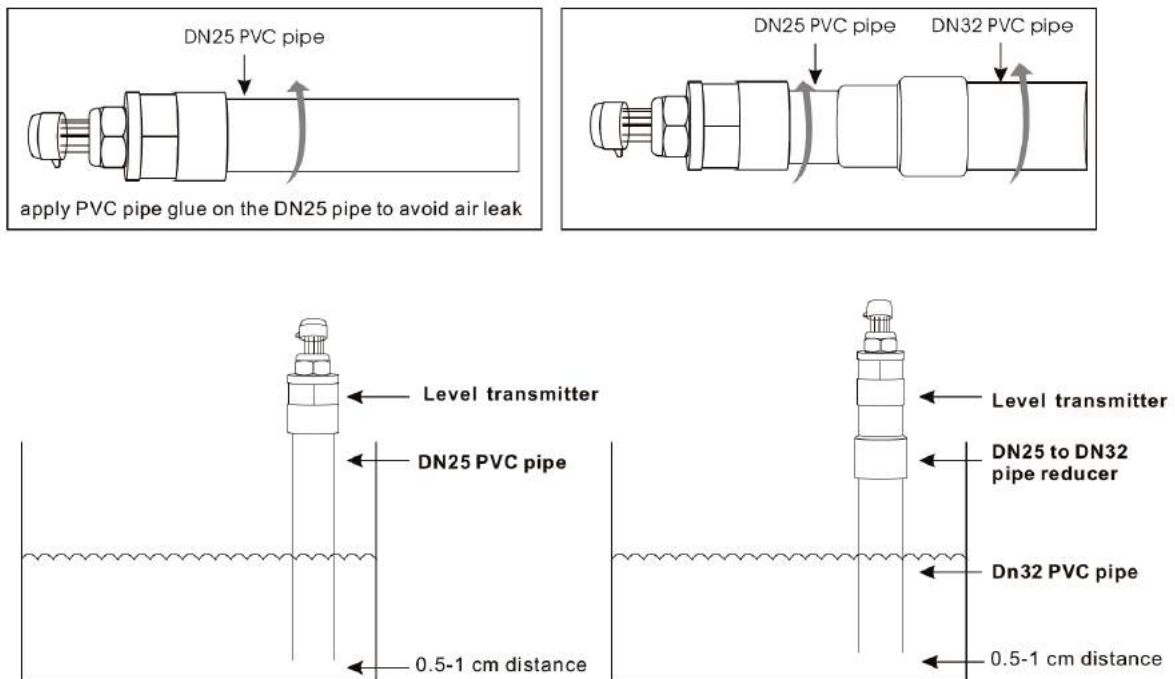

#### Installation notes:

- 1) The distance between the bottom of the PVC pipe and bottom of the sump or tank should be 0.5 – 1.0 cm.
- 2) If there is sludge in the sump or tank, a DN32 pipe with DN32 to DN25 pipe reducer is recommended.
- 3) There is a small breather hole at the transducer to prevent the transducer/pipe assembly water-logging and giving false readings.



## 2.2.2 Installing level transducer

The following chart shows the main technical parameters of the pressure transducer.

Main technical data	Value
Measuring Range	0 - 2 metre depth range
Power Supply	5 +/- 0.5 VDC
Output Signal	0.5 - 4.5 V
Accuracy	+/- 2% FS (-10 - 100 deg C)
Overload Pressure	2 x rated pressure
Breakage Pressure	3 x rated pressure
Insulation	> Mohm@50V
Response Time	<10ms
Wires	Three wire
Electrical Connector	Packard
Pressure Port	1/2" BSPM
Shell Protection	IP68

Dimension and pin definition.

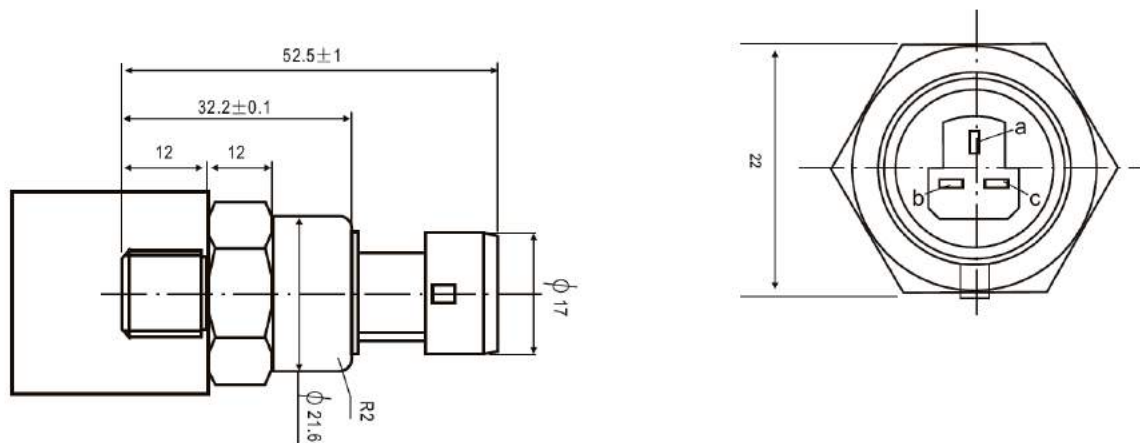

Pin Definition		
a	VOUT	Yellow colour wire
b	VCC	Red colour wire
c	GND	Black colour wire

### 2.2.3 Electrical connections.

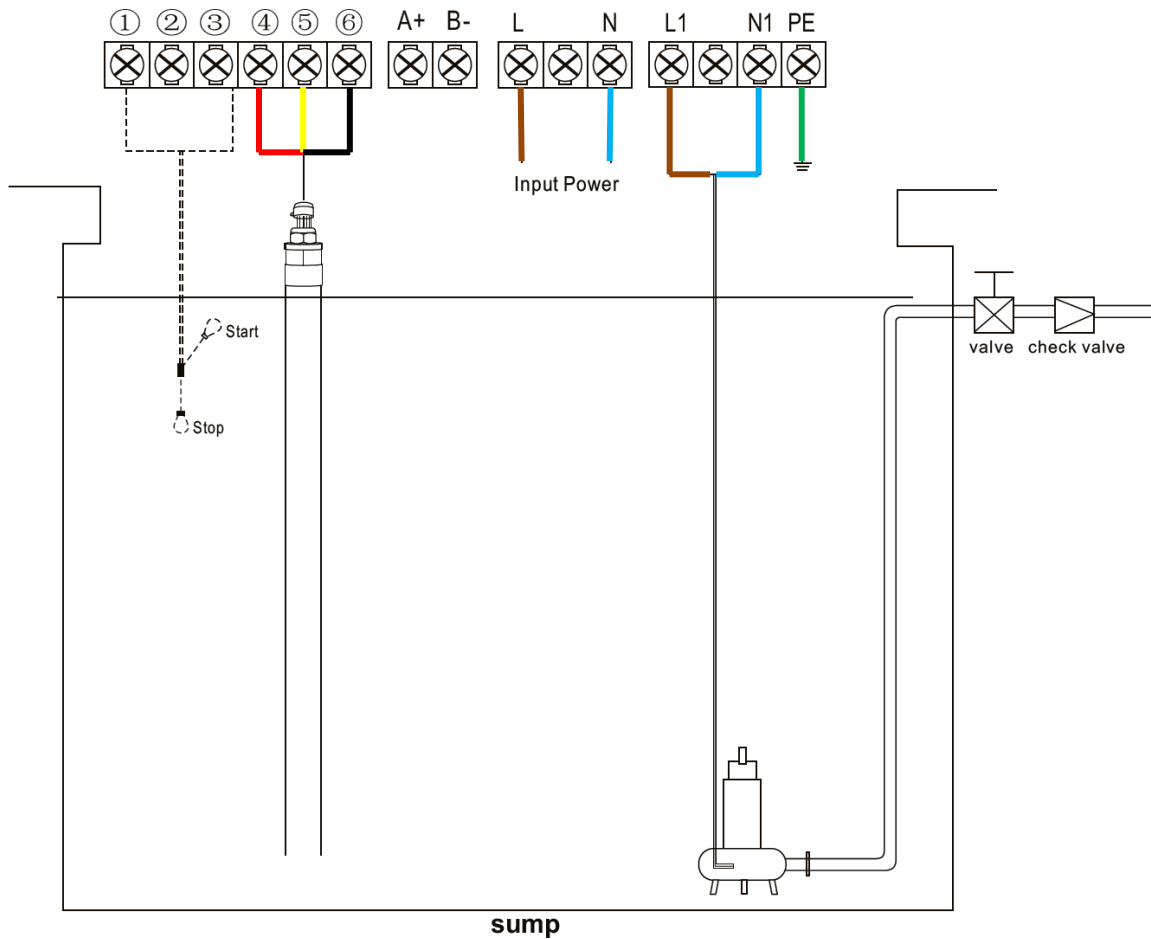
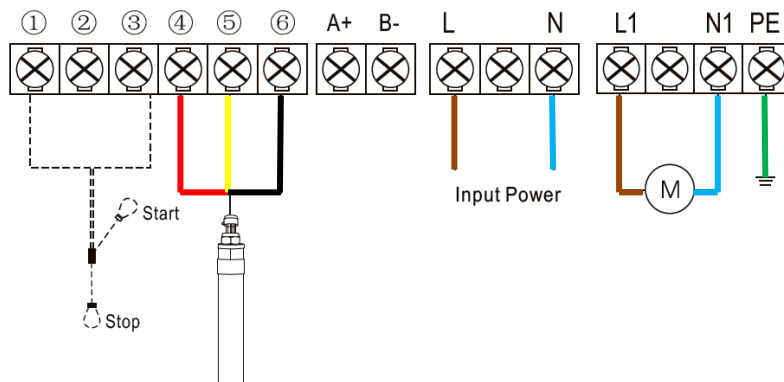

Note: In case of level transducer fault, a back up float switch can be used. When the float switch is up, the pump will operate. Float switch is optional extra.

### 3.0 OPERATION

#### 3.1 BEFORE YOU START – Parameter calibration and erasing.

To achieve best level of protection of the pump, it is essential that parameter calibration be done immediately after successful pump installation or pump maintenance.

##### Setting the parameter calibration.

**Pump/s must be able to pump water to enable correct calibration. If pumps are calibrated without water, overload and pump stalled errors may occur later.**

**If calibration is required without water, please contact White International for advice.**

Press the **MODE** key to switch to manual state. If the control panel is locked press **MODE** and **STORE** keys at the same time to unlock and go into manual mode. Make sure that the pump is not running

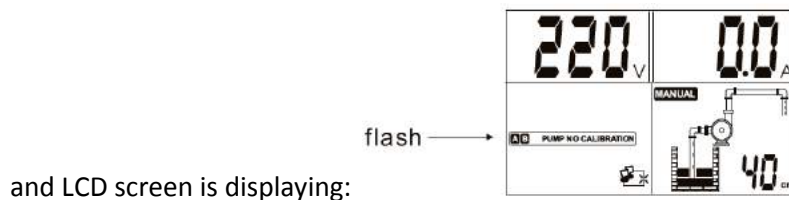

and LCD screen is displaying:

Press the **START** key to run pump, confirm the pump and all pipe network is in normal working state (including voltage, amps etc) with LCD screen displaying:

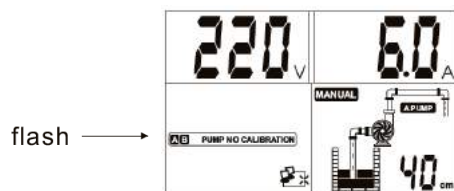

Press the **STORE** button. The control panel makes a “beep” and a countdown starts with the LCD

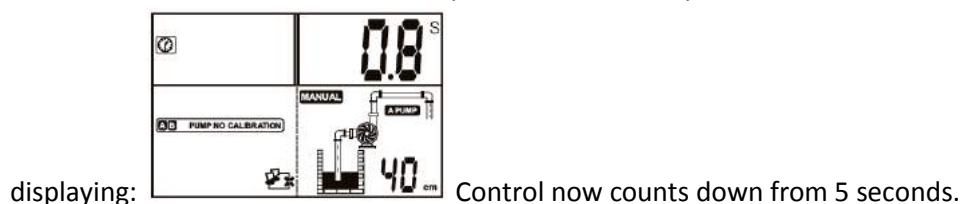

The pump stops running and parameter calibration is completed with LCD displaying:

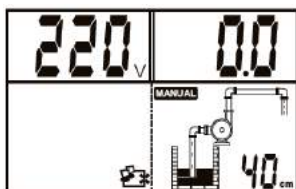

**Erasing former parameter.** When pump is reinstalled after maintenance or a new pump is installed, user must erase the former calibration and a new calibration must be done.

### Erasing the parameter calibration.

Press the **MODE** key to switch to manual state. If the control panel is locked press **MODE** and **STORE** keys at the same time to unlock and go into manual mode. Make sure the pump is not running and



Press the **STOP** key for 30 seconds; the control panel makes a “beep” sound, and the control panel

recovers the default factory setting and the LCD displays:  
Pump No Calibration flashing.

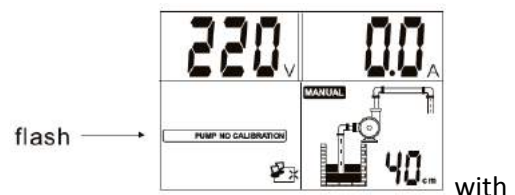

### 3.2 Switching to AUTO mode.

To switch between MANUAL and AUTO mode press **MODE**. AUTO mode automatically locks control panel. Under auto state the control panel will run or stop the pump according to the signal from the liquid level probe or float switch.

**Note:** under auto state, if the pump is running and user wants to stop the pump, press the **MODE** key to switch to manual state and the pump stops.

**Note:** under auto state, if the input power is cut off and the recovers, the control panel will enter operating state after 10 seconds countdown

**Note:** no matter if the control panels is under auto or manual state, if the input power is cut of and recovers again, the control panel will resume its operation in the same state as before the power being cut off.

#### 3.2.1 AUTO mode working logic description

Note: suppose pump user sets the

- Cut off liquid depth value at 20 cm
- Pump cut in liquid depth value 60 cm
- Over flow alarm liquid depth value 100 cm

##### 1) Normal liquid depth in sewage tank

If liquid depth in the sewage tank is 60cm, controller will order pump to run, when depth value drops to 20cm, pump stops running

##### 2) Overflow alarm in sewage tank

When pump is running, liquid level in the sewage tank still rising to 100cm, controller will sound warning alarm

### 3.3 Switching to MANUAL mode.

To switch between AUTO and MANUAL model press **MODE** and **STORE** keys at the same time to unlock and go into MANUAL mode. Press the **START** key to start the pump and the **STOP** to stop the pump.

### 3.4 Auto Patrol (Pump anti seize function).

Under auto state, if controller inspects pump not running for 10 days, controller will order pump to run for 3 seconds to prevent impeller jamming by rust.

### 3.5 Alarm Test and Mute.

Under MANUAL mode and pump/s not operating press **STORE** for 3 seconds to test the alarm. To Mute the alarm press **STOP** at any time.

### 3.6 Pump Protection

During pump running, if dry run, overload, over voltage, etc failures occur, the control panel will immediately shut down the pump running and automatically execute a check for restarting conditions after a built in time delay has elapsed. The control panel will not recover automatically until all the abnormal situations have been cleared.

If pump stalled, open phase or other serious failure has occurred, pump user must immediately check pump and motor.

### 3.7 Last five failure record

The control panel can memorize the last five failures of pump, so it is very convenient for the users to analyse the pump running conditions.

#### Displaying the last five failure record.

Press the **MODE** key to switch to manual state, make sure the pump is not running and the LCD screen is displaying:

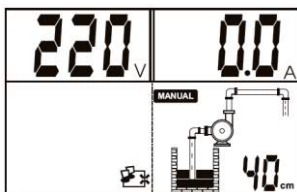

Hold pressing **STOP** key and press **MODE** key, the control panel makes a “beep” sound and displays the pump failure record. Pressing **MODE** key displays pump failure record sequentially.

Press the **STOP** key to quit the failure record display;

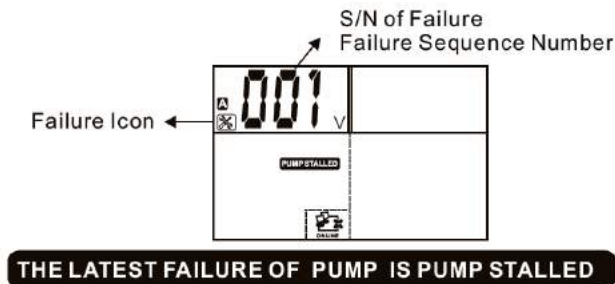

### 3.8 Pump accumulative running time

The control panel can memorise how many hours of pump running, so it is very convenient for the pump user to analyse the pump running conditions and do maintenance.

**Displaying the pump accumulative running time.**

Press the **MODE** key to switch to manual state, make sure that the pump is not running and the LCD screen is displaying:

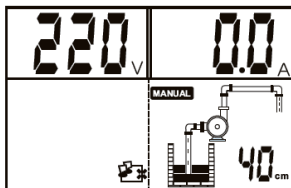

Hold pressing the **STORE** key and press the **STOP** key. The control panel makes a “beep” sound and displays the accumulative run time.

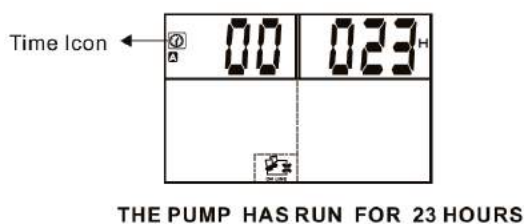

Press the **STOP** key to quit the accumulative running time display.

## 4.0 SETTING LEVELS

### 4.1 Cut off depth value setting

Press the **MODE** key to switch to manual state, make sure the pump is not running and LCD screen is displaying:

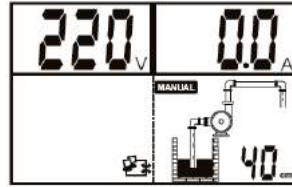

Hold pressing **STORE/SET** key and click  to add or to decrease the cut off depth value,

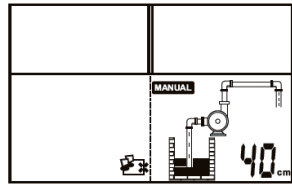

Loosen **STORE/SET** key, controller makes a beep sound, cut off depth value setting complete.

### 4.2 Cut in depth value setting

Press the **MODE** key to switch to manual state, make sure the pump is not running and LCD screen is displaying:

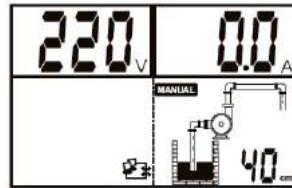

Hold pressing **STORE/SET** key and click  to add or to decrease the pump cut in depth value,

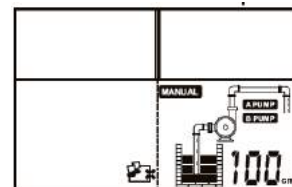

Loosen **STORE/SET** key, controller makes a beep sound, cut in depth value setting complete.

### 4.3 High Level alarm setting

Press the **MODE** key to switch to manual state, make sure the pump is not running and LCD screen is displaying:

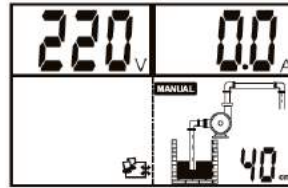

Hold pressing **STORE/SET** key and click **START** key to add or **STOP** key to decrease the high level alarm value,

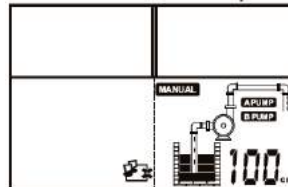

Loosen **STORE/SET** key, controller makes a beep sound, high level alarm value setting complete.

### 5.0 Communication link.

The control panel has communication interface, that along with the optional Slave Controller, users can realise a long distance monitoring function.

This function applies to where the control panel is installed in the basement or pumping room, but users require to monitor and control the pump on the ground or in a control room.

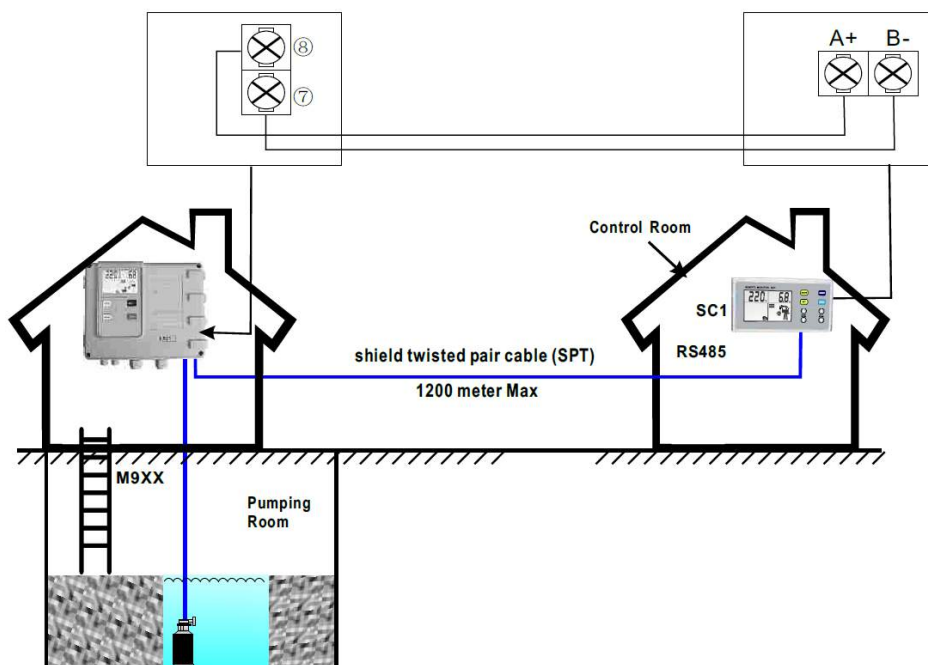



## 5.1 Basic function.



Slave Controller (SC) with communication interface can realize long distance monitoring. In the control room, users can realize all the functions of the master control panel through the SC, except parameter calibration and adjusting.

## 5.2 Special application.

As adopting communication interface, the wire communication distance is less than 1200 metres. For those installation environments which require a longer distance communication, i.e., mine, water tower, across railway road and bridge etc., users can adopt RS485 extender, wireless communication or GSM. Please contact the manufacturer for more information.

## 5.3 Technical parameters.

The following chart shows main technical parameters of communication between the control panel and the slave controller.

<b>Main technical data</b>	
Physical interface	RS485 Bus Interface: asynchronous semi duplex
Data format	1 start bit, 8 data bit, 1 stop bit, no verify 1 start bit, 8 data bit, 2 stop bit, no verify Default: 1 start bit, 8 data bit, 1 stop bit, no verify
Baud rate	1200,2400,4800,9600 bps (default 9600bps)
Communication address	Setting range of controller address: 1-126 127: broadcast address, host computer broadcasting, slave machine response forbidden
Protocol type	MODBUS protocol (RTU)
Rated input voltage for SC	AC 240V/50Hz, single phase
<b>Main installation data</b>	
Wire communication distance	1200 metres max by shield twisted pair cable (STP) for RS485 & CAN 5000 metres max by STP and RS485 extender
STP	STP-120U one pair 20AWG for RS485 & CAN
RS485 extender	5000 metres (9600bps)

## 6.0 Trouble shooting guide

Fault Message	Possible Cause	Solutions
flashing of <b>UNDER V</b>	the real running voltage is lower than the calibrated voltage, pump is in under voltage protection state	report low line voltage to the power supply company Control will attempt to restart the pump every 5 min until line voltage is restored to normal
flashing of <b>OVER V</b>	the real running voltage is higher than the calibrated voltage, pump is in over voltage protection state	report low line voltage to the power supply company Control will attempt to restart the pump every 5 min until line voltage is restored to normal
flashing of <b>OVER LOAD</b>	the real running ampere is higher than the calibrated running ampere, pump is in over load protection state	Control will attempt to restart the pump every 30 min until running ampere is restored to normal
	pump damaged	inspect pump
flashing of <b>PUMP NO CALIBRATION</b>	parameter calibration not completed	refer to parameter calibration setting
flashing of <b>DRY RUN</b>	liquid level in the well / sump is below the pump intake, pump stops running	Control will attempt to restart the pump every 30 min until liquid level is above the pump intake
flashing of <b>PUMP STALLED</b>	pump running amps exceeded normal run amps by more than 200%	cut off power supply and repair or replace pump
flashing of <b>REPEATED START</b>	pump starts more than 5 times per minute	Check pressure tank precharge Check pressure tank bladder Check pressure switch settings Check pressure switch for defects
	no communication link between SC / computer and Control	connect the Control to SC / computer to realize long distance monitoring



**WHITE** 2 YEAR WARRANTY  
INTERNATIONAL

White International Pty Ltd  
Limited Product Warranties  
TERMS & CONDITIONS

This warranty is given in addition to the consumer guarantees found within the Australian Competition and Consumer Act 2010 (Cth) for goods purchased in Australia and the Consumer Guarantees Act 1993 NZ for goods purchased in New Zealand:

- 1) White International Pty Ltd / White International NZ Ltd (White International) warrant that all products distributed are free from defects in workmanship and materials, for their provided warranty period as indicated on the top or opposite side of this document. Subject to the conditions of the warranty, White International will repair any defective products free of charge at the premises of our authorised service agents throughout Australia and New Zealand if a defect in the product appears during the warranty period. If you believe that you have purchased a defective product and wish to make a claim under this warranty, contact us on our Sales Hotline on 1300 783 601, or send your claim to our postal address or fax line below and we will advise you as to how next to proceed. You will be required to supply a copy of your proof of purchase to make a claim under this warranty.
- 2) This warranty excludes transportation costs to and from White International or its appointed service agents and excludes defects due to non-compliance with installation instructions, neglect or misuse, inadequate protection against the elements, low voltage or use or operation for purposes other than those for which they were designed. For further information regarding the suitability of your intended application contact us on our Sales Hotline on 1300 783 601. If you make an invalid claim under this warranty, the original product will be sent back to you unrepai red.
- 3) This warranty refers only to products sold after the 1st January 2012, and is not transferable to another product type and only applies to the original owner, purchaser or end user, and is in addition to the consumer guarantees found within the Competition and Consumer Act 2010 (Cth) for goods purchased in Australia and the Consumer Guarantees Act 1993 (NZ) for goods purchased in New Zealand.



WHITE INTERNATIONAL PTY LTD  
ABN 48 0001 19380  
52-60 Ashford Ave, MILPERRA NSW 2214  
PO BOX 304, MILPERRA LPO NSW 2214  
Ph: 02 9783 6000 Fax: 02 9783 6001  
Customer Service Hotline: 1300 783 601  
Customer Service Faxline: 02 9783 6003  
EMAIL: Sales Enquiries: info@whiteint.com.au

WHITE INTERNATIONAL NZ LTD  
138 Hugo Johnston Dr PENROSE, AUCKLAND, NZ  
PO BOX 12704, PENROSE, AUCKLAND  
Ph: 09 579 977 Fax: 09 579 7775  
Customer Service Hotline: 0800 509 506  
Customer Service Faxline: 0800 804 344  
EMAIL: General Info Enquiries: sales@whiteint.co.nz





**WHITE**  
INTERNATIONAL

**2 YEAR WARRANTY cont.**

- 4) Our goods come with guarantees that cannot be excluded under the Australian Consumer Law. You are entitled to a replacement or refund for a major failure and for compensation for any other reasonably foreseeable loss or damage. You are also entitled to have the goods repaired or replaced if the goods fail to be of acceptable quality and the failure does not amount to a major failure.
- 5) To the fullest extent permitted by law, White International excludes its liability for all other conditions or warranties which would or might otherwise be implied at law. To the fullest extent permitted by law, White International's liability under this warranty and any other conditions, guarantees or warranties at law that cannot be excluded, including those in the Competition and Consumer Act 2010 (Cth), is expressly limited to:
  - (a) in the case of products, the replacement of the product or the supply of equivalent product, the payment of the cost of replacing the product or of acquiring an equivalent product or the repair of the product or payment of the cost of having the product repaired, is at the discretion of White International or a 3rd party tribunal elected under the Competition and Consumer Act 2010 (Cth) for goods purchased in Australia and the Consumer Guarantees Act 1993 (NZ) for goods purchased in New Zealand; and
- 6) To the fullest extent permitted by law, this warranty supersedes all other warranties attached to the product or its packaging.
- 7) In the case of services, supplying the services again or the payment of the cost of having the services supplied again, is at the discretion of White International or a 3rd party tribunal elected under the Competition and Consumer At 2010 (Cth) for goods purchased in Australia and the Consumer Guarantees Act 1993 (NZ) for goods purchased in New Zealand.
- 8) Our warranty commences from the date of purchase of the above mentioned pumps. Proof of purchase is required before consideration under warranty is given. Record your date of purchase in the space below and retain this copy for your records.

Date of Purchase .....

Model Purchased .....



**WHITE**  
INTERNATIONAL

WHITE INTERNATIONAL PTY LTD  
 ABN 48 000119380  
 52-60 Ashford Ave, MILPERRA NSW 2214  
 PO BOX 304, MILPERRA LPO NSW 2214  
 Ph: 02 9783 6000 Fax: 02 9783 6001  
 Customer Service Hotline: 1300 783 601  
 Customer Service Faxline: 02 9783 6003  
 EMAIL: Sales Enquiries: info@whiteint.com.au

WHITE INTERNATIONAL NZ LTD  
 138 Hugo Johnston Dr PENROSE, AUCKLAND, NZ  
 PO BOX 12704, PENROSE, AUCKLAND  
 Ph: 09 579 977 Fax: 09 579 7775  
 Customer Service Hotline: 0800 509 506  
 Customer Service Faxline: 0800 804 344  
 EMAIL: General Info Enquiries: sales@whiteint.co.nz